



K80 Floor Scrubber Instruction Manual

We explore safer, higher-end and more user-friendly cleaning equipment through technical advantage and idea innovation.











Preface

This instruction manual contains all the information that you need to use and maintain the machine. Please read it carefully before getting started.

This instruction manual is an important part of the product and should be kept together with the machine.

In order to ensure your safety, the following instructions must be followed when operating the machine and performing maintenance:

-  Do NOT use the machine after drinking or taking medicine.
-  Turn off the machine before any maintenance or repair.
-  The machine can only be used by trained and competent personnel; children and disabled people are forbidden to use it.
-  Keep the batteries away from sparks, flame and smoke.
-  Do NOT use the machine in places with flammable or explosive liquids, gases and vapor.
-  When operating the machine, do NOT wear loose clothing, and keep you body away from the moving parts of the machine.
-  Do NOT smoke when charging the batteries.
-  In the event of a fire, use a powder extinguisher instead of water.
-  Attention must also be paid when the machine is about to be scrapped. Since some harmful substances have met the standards, they should be sent to a specific service center for treatment.

If you have any question, complaint or suggestion, please feel free to contact us and we will be at your service with all our knowledge and enthusiasm.

We wish you a pleasant experience with our product!

Contents

Chapter 1 General description	1/2
1.1 Suitable scenes	
1.2 Overview of the product	
1.3 Controlling panel and keys	
1.4 List of accessories	
1.5 Consumables and optional items	
Chapter 2 Unloading and assembling the machine	3
2.1 Unloading the machine	
2.2 Assembling the machine	
Chapter 3 Checks and adjustments before using the machine	4/5
3.1 Check items	
3.2 Adjustment items	
Chapter 4 Instructions on operating the machine	6/8
4.1 Walking of the machine	

4.2 Scrubbing the floor	
4.3 Discharging sewage	
4.4 Stopping the machine	
4.5 Charging the batteries	
Chapter 5 Cleaning and maintenance of the machine	9/11
5.1 Cleaning of the machine	
5.2 Maintenance of the machine	
Chapter 6 Storage and transportation of the machine	12
6.1 Storage of the machine	
6.2 Transportation of the machine	
Chapter 7 Common problems and solutions	13
Chapter 8 After-sale services	14
8.1 General description	
8.2 Contents of warranty	
8.3 Cases not covered in the warranty	
Technical parameters & Warranty card	

Chapter 1 General description

1.1 Suitable scenes

This product can be used in multiple scenes such as restaurants, schools, hospitals, factories, supermarkets and office buildings and has a good cleaning effect on floors of epoxy, PVC, terrazzo, ceramic tile, wood and rubber.

1.2 Overview of the product

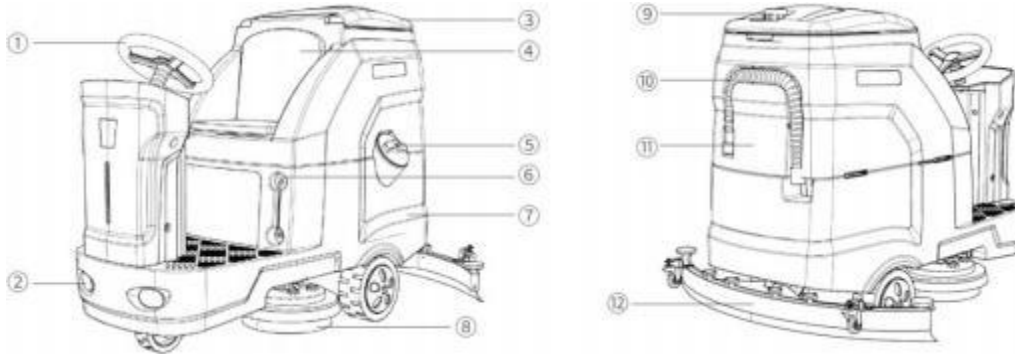

- | | | | |
|---------------------|---------------------|--------------------|----------------|
| 1 Steering wheel | 4 Seat back | 7 Clean water tank | 10 Sewage pipe |
| 2 Headlight | 5 Water inlet | 8 Brush plate | 11 Sewage tank |
| 3 Sewage tank cover | 6 Water level gauge | 9 Alarming light | 12 Squeegee |

1.3 Controlling panel and buttons

- | | | | | |
|------------|------------------------------|--------------------------|----------------------------|----------------|
| 1 Turn-off | 4 Power display screen | 7 Speed up/slow down | 10 Brush plate motor | 13 Loudspeaker |
| 2 Turn-on | 5 Fault light | 8 Forward | 11 Suction motor | 14 Main light |
| 3 ECO | 6 Full sewage tank indicator | 9 Start/stop the machine | 12 Water amount adjustment | 15 Backward |



1.4 List of accessories

When you receive the product, check whether all of the following items are presented. If there is any loss, contact the seller immediately.

Item	Number	Item	Number	Item	Number	Item	Number
Scrubber	1	Squeegee	1	Instruction manual	1	Spare fuses	2
Charger	1	Tool box	2	Warranty card	1		

1.5 Consumables and optional items

- ⊗ Consumables refer to accessories that become worn gradually and need to be replaced when they cannot work normally.
- ⊗ You can purchase consumables and optional accessories from the original manufacturer.

Consumables			Optional items	
Brush plate	Needle plate	Scouring pad (black)	Needle plate	Scouring pad (black)
Squeegee strip	Scouring pad (red)	Scouring pad (white)	Scouring pad (red)	Scouring pad (white)

Chapter 2 Unloading and assembling the machine

2.1 Unloading the machine

- ③ Remove the packing with caution to avoid damaging the surface of the machine.
- ③ We recommend that you keep the packing since it may be used again if you need to transfer the machine to another place.
- ③ Do NOT unload or unpack the machine violently.

2.2 Assembling the machine

2.2.1 Installing the squeegee

- ③ Turn on the suction motor and the squeegee holder will be lowered.
- ③ When the squeegee holder touches the ground, turn off the switch.
- ③ Pass the squeegee fixing screws through the holes of the squeegee holder, and tighten them with plastic knobs.

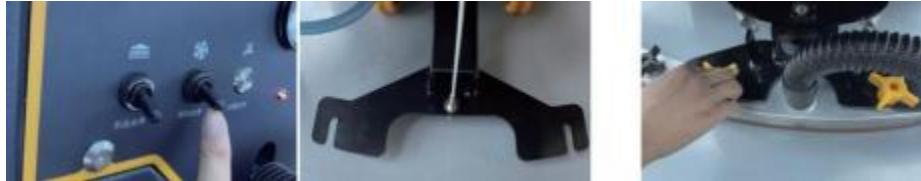

2.2.2 Connecting the battery cords

- ③ Open the sewage tank and check whether all the cables on the batteries are connected and tightened.
- ③ Connect the battery poles. Pay attention to the polarity.
- ③ Close the sewage tank.

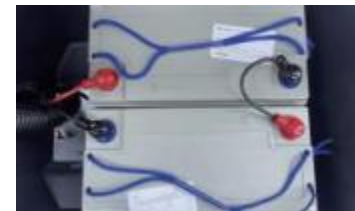

Chapter 3 Checks and adjustments before using the machine

3.1 Check items

3.1.1 Checking the water volume in the clean water tank

- ⚠ Make sure that there is sufficient water in the clean water tank before work. Do NOT do the cleaning without enough water, or dust may be sucked into the suction motor leading to loud noise and low working efficiency.

3.1.2 Checking the water level in the sewage tank

- ⚠ Pay special attention to the water level in the sewage tank. When the floating balls are in the highest position, discharge the sewage tank immediately or the suction motor will be burnt.



3.1.3 Checking the voltage of the batteries

- ⚠ When the general switch is turned on, the current voltage of the batteries will be displayed on the voltmeter. If the last bar of the voltmeter is flashing, the power is insufficient and please charge the batteries immediately.
- ⚠ Note that deep discharging (e.g. frequently using the machine when the voltage is lower than 21 V) will reduce the service life of the batteries.



3.1.4 Checking the degree of wear of the brush plate

- ⊕ Check whether the brush plate is worn. If so, adjust the height of the brush plate or replace it.



3.1.5 Checking the degree of wear of the strip

The strip needs to be replaced if:

- ⊕ the strip cannot touch the ground when the squeegee is put down, or
- ⊕ the strip is cracked.



3.2 Adjustment items

3.2.1 Adjustment of the squeegee holder

- ⊕ Use the nuts on the universal wheels to lift or lower the squeegee holder.



Chapter 4 Instructions on operating the machine

4.1 Walking of the machine

- ④ When the machine is not turned on, you can push it after the brush plate and the squeegee are lifted.
- ④ Turn on the switch, put down the brush plate and the squeegee; turn on the brush plate button and the squeegee button, and then push the machine forward.

Note: when the machine is moving backward or needs to be transported, make sure that the brush plate and the squeegee are lifted, or the brush plate will be worn and the squeegee will be deformed.



4.2 Scrubbing the floor

- ④ Turn on the general switch.
- ④ Turn on the brush plate button, and the brush plate will be put down automatically.
- ④ Turn on the suction button, and the squeegee will be put down automatically.
- ④ Hold the steering wheel, step on the accelerating pedal and keep the machine running smoothly.

Note:

1. If you need to drive the machine forward, please turn the forward/backward button to the forward gear.
2. If you need to drive the machine backward, please turn the forward/backward button to the backward gear. (In this case, make sure that the brush plate and the squeegee are lifted.)
3. When adding clean water, pay attention to the water quality to avoid blockage.
4. For emergency stop or when operating the machine on a slope, you can release the accelerating pedal.

5. When washing epoxy floor, please replace the ordinary brush plate with a needle plate with a scouring pad.
6. In you need to wash heavily polluted floor, you can add a certain amount of detergent to the clean water tank. In this case, the use of defoamer is indispensable, or foam may penetrate the suction motor causing it to be burnt.
7. When the brush plate motor is turned on, do NOT leave the machine in the same place for a long time.
8. The sewage tank is equipped with a water level sensor. When the water level in the sewage tank is too high, the suction motor will be stopped automatically and the user needs to discharge the sewage.
9. In winter or very cold regions, please discharge the clean water tank once the work is finished.



4.3 Discharging sewage

- ① Before discharging the sewage tank, stop the machine and turn off the general switch.
- ② Put down the sewage discharging pipe, open the cap and discharge the sewage.
- ③ Use clean water to wash the sewage tank.



4.4 Stopping the machine

- ① Discharge the sewage tank.
- ② Move the machine to the storage place.
- ③ Turn off all the buttons on the controlling panel.

☹ Lift the brush plate and the squeegee.

Note: if the machine is not about to be used for a long time, please fully charge the batteries, disconnect the battery cords to avoid power loss.

4.5 Charging the batteries

Note: the machine is powered by two 12 V maintenance-free lead-acid batteries and the total system voltage is 24 V.

- ☹ The total voltage of the batteries will gradually decrease during the work. When the last bar of the voltmeter is flashing, the machine is running out of power and charge the batteries immediately.
- ☹ When maintaining the batteries, please wear gloves to avoid contact with acid substances.
- ☹ Check whether the battery cords are worn and the connecting parts are loose, and replace them when necessary.
- ☹ Keep the batteries dry and clean and make sure that there are no dust on them, since it is extremely harmful to the batteries and may even cause them to burn in severe cases. Do NOT put any object (especially metallic object) on the batteries either.
- ☹ In order to extend the service life of the batteries, charge them immediately when the cleaning work is finished. Deep discharging is strictly forbidden for it will reduce their capacity and service life.
- ☹ The correct steps of charging the batteries: first install the batteries, then connect them to the mains.
- ☹ If the machine is not about to be used within a long period of time, please fully charge the batteries and disconnect the battery cords.

Chapter 5 Cleaning and maintenance of the machine

Regular maintenance can extend the service life of your machine.

5.1 Cleaning of the machine

- ④ Check the wheels regularly and remove entanglements.
- ④ Clean the sewage tank and the sewage discharging pipe with clean water regularly.
- ④ Clean the filter of the water valve. If there are impurities in its transparent cover, unscrew the filter and wash the cover and the filter screen repeatedly.

Alert: do NOT wash the machine body with water directly, since it is NOT strictly water-proof and may be short-circuited or burnt in this case.

5.2 Maintenance of the machine

5.2.1 Replacement of the brush plate

- ④ Park the machine on the flat ground and put down the brush plate.
- ④ Rotate the plastic handle counterclockwise to remove the brush.
- ④ Grab the bristles, lift the brush plate slightly and shake it from side to side, and then the brush plate will be removed.
- ④ When installing the new brush plate, make sure that the flange plate is aligned with the holes on the brush plate, and rotate it in any direction to finish the installation.
- ④ Installation of the needle plate: add a scouring pad on the bottom of the needle plate, and install it following the instructions above. You can purchase needle plates and scouring pads from the original manufacturer.



5.2.2 Replacement of the strip of the squeegee

- ④ Use the squeegee lifting button to lower the squeegee, rotate the plastic handle and take out the squeegee.
- ④ Remove the rear wheels of the squeegee, use a wrench to remove the fixing nuts of the squeegee, unscrew the fixing knob of the squeegee bar, and take out the bar, the front strip, the rear strip and the squeegee.
- ④ Install the new squeegee and tighten the rear wheels and the fixing nuts.



5.2.3 Removal and installation of the filter

- ⌚ The filter is located on the right side of the front wheel. When the machine has been used for a period of time, if the water output is small or no water outlet is produced, unscrew the transparent cover on the bottom of the filter and clean the filter screen.



Chapter 6 Storage and transportation of the machine

6.1 Storage of the machine

- ⚠ If you do not need to use the machine for a long time, please remove and wash the squeegee and the brush plate, and store them in a dry clean place. We recommend that you store them in an airtight plastic container.
- ⚠ Make sure that the water tanks are discharged and cleaned.
- ⚠ Charge the battery before storing the machine. If you do not use the machine for a long time, charge the battery regularly (at least once a month) to make sure that it has enough power.

6.2 Transportation of the machine



- ⚠ When lifting or lowering the machine, make sure that it is in a stable position to prevent it from tipping over or falling.
- ⚠ When the machine leaves the factory, it is fixed on a wooden pallet and carried on a transport vehicle with appropriate equipment; upon arrival at the destination, the same equipment must be used for loading and unloading.
- ⚠ When using a forklift to move the machine, it must be handled together with the packing; avoid the machine from tipping over or falling during the operation.

Chapter 7 Common problems and solutions

The batteries cannot be charged.	The charger fails.	Replace the charger.
	The charging port is oxidized.	
The suction motor does not work.	The fuse is blown.	Replace the fuse.
The brush plate motor does not work.	The fuse is blown.	Replace the fuse.
No water outlet is produced.	The clean water pipe is blocked.	Clean the water pipe.
	There are impurities in the filter cover.	Clean the filter cover.
	The electromagnetic valve fails.	Check the electromagnetic valve.
Loud noise is produced.	The squeegee is in the wrong position.	Adjust the height of the universal wheels of the squeegee.
	The suction motor is broken.	Replace the suction motor.
The brush plate	The brush plate drops often.	Improper operation.
	The brush plate buckle is worn.	Replace the buckle.
The water suction efficiency is low.	The floating ball cage is blocked.	Clean the floating ball cage.
	The suction pipe is blocked.	Clean the suction pipe.
	The sealing of the sewage tank is cracked.	Replace the sewage tank.
	The strip of the squeegee is cracked.	Replace the strip.

Chapter 8 After-sale services





8.1 General description

-  Seven-day guaranteed return, fifteen-day guaranteed replacement, one-year warranty for the whole machine, 6-month warranty for damaged parts, and no warranty for consumables (calculated from the next day after receiving the machine).
-  The delivery receipt and purchase invoice are certificates for warranty and must be kept properly.

8.2 Contents of warranty

Category	Contents	Warranty period
	The entire machine	1 year
Damaged parts	Fuses, universal wheels, electromagnetic valve, flange buckles, filter	6 months
Consumables	Brush plate, scouring pad, needle plate, sealing strip	No warranty

8.3 Cases not covered in the warranty

-  The operator fails to perform maintenance according to the instruction manual, resulting in damage or failure.
-  The surface and/or the structure of the machine are obviously damaged due to improper operation.
-  Disassembly or modification not approved by the original manufacturer.
-  Damage due to weather or force majeure.
-  The warranty is expired or the machine has been used for more than 1,500 hours.

Technical parameters

Category	K80
Battery capacity (V/Ah)	24/200
Suction motor (W)	600
Brush plate motor (W)	350 * 2
Cleaning width (mm)	800
Theoretical working efficiency (m ² /h)	6,500
Total weight (kg)	345.5
Working time (h)	3-5
Clean water tank capacity (L)	138
Sewage tank capacity (L)	140
Product size (mm)	1,520 * 1,200 * 1,300

Warranty Card

用户名 User's name		联系电话 Tel	
通讯地址 Address		票据号 Bill No.	
购买时间 Date of purchase		机身编号 Serial number	
产品型号 Type of product		日期 Date	

更换配件：
Accessories to be replaced:

故障描述：
Fault description: